



# OPTIMIZING PERFORMANCE BY APPLYING THE FUNDAMENTALS

By: Richard Storm and Staff of Storm Technologies, Inc.

STORM TECHNOLOGIES, INC.

EPRI



# Typical Operation & Maintenance Expenses for Fossil Plants Including Fuel

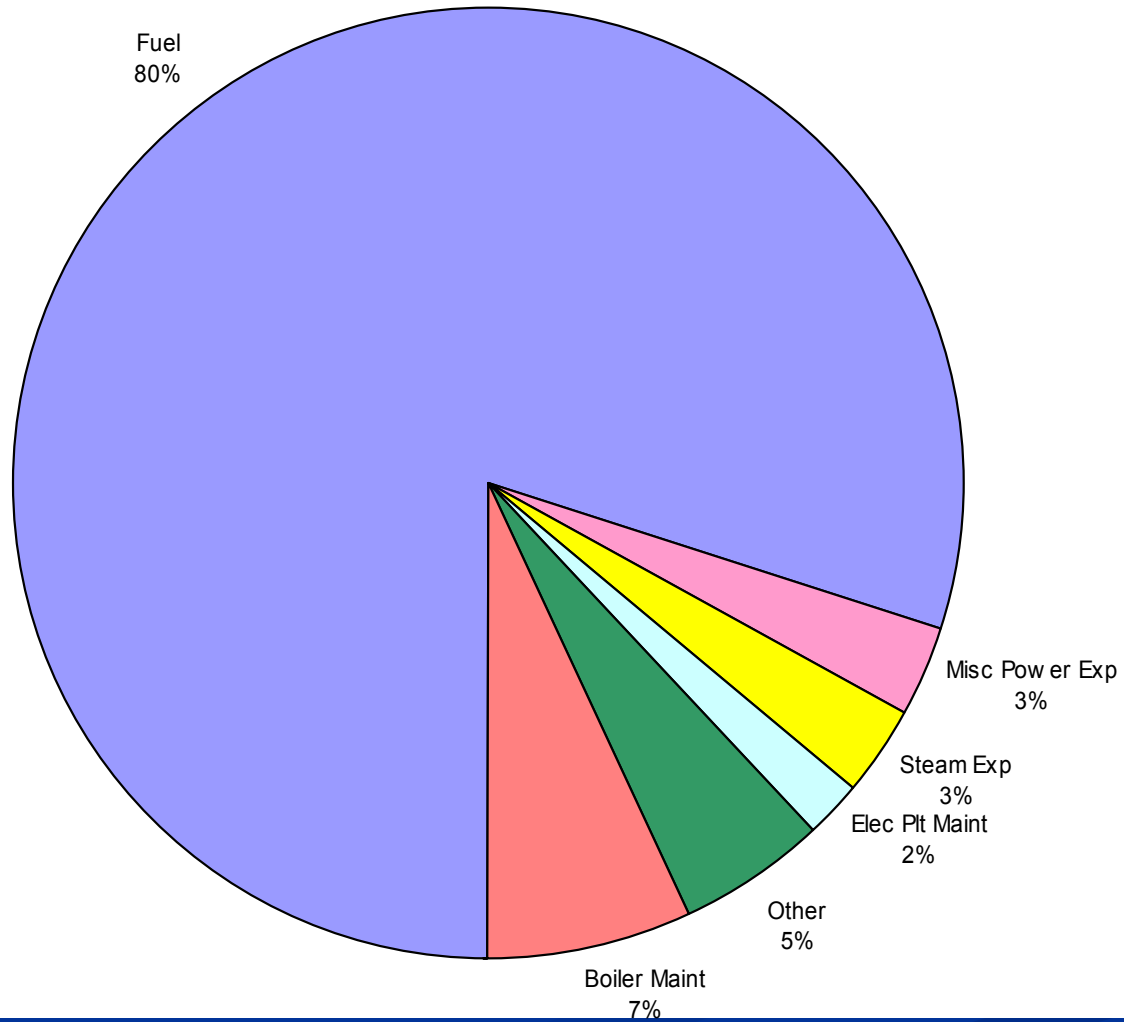

## Typical Operation and Maintenance Expenses for Fossil Fuel Plants Excluding Fuel

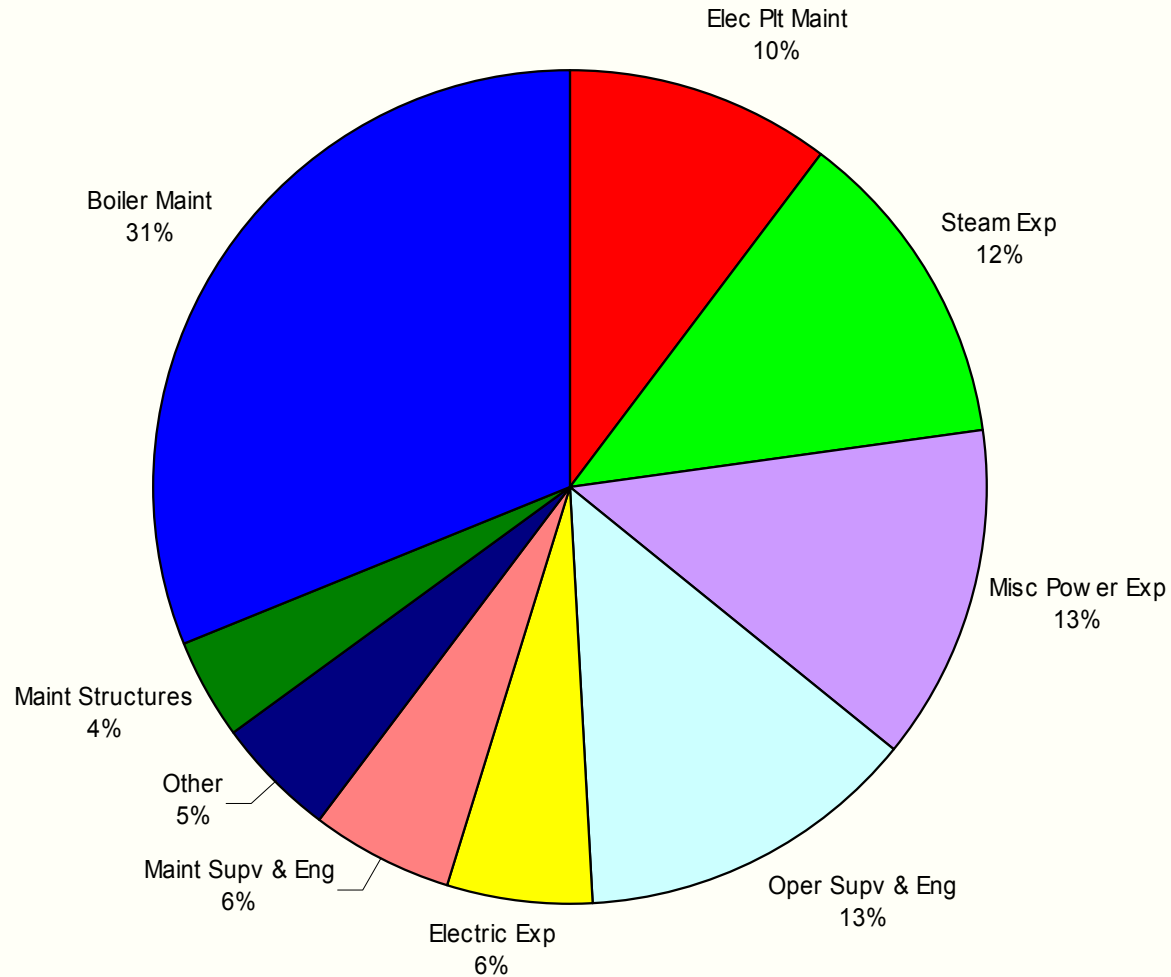

# U.S. ELECTRICITY GENERATION BY SOURCE

<u>SOURCE</u>	<u>YEAR 2000</u>	<u>YTD 2001</u>	% Change kWh produced 2000 vs. 2001
Coal	51.3	51.5	+1.8
Nuclear	20.0	20.0	+1.0
Natural Gas	16.0	16.4	+4.1
Hydro	8.0	5.9	-24.9
Oil	2.5	3.9	+58.8
Renewables	2.2	2.3	+5.0

\*Source: Nuclear Energy Institute



# Heat Rate Medians

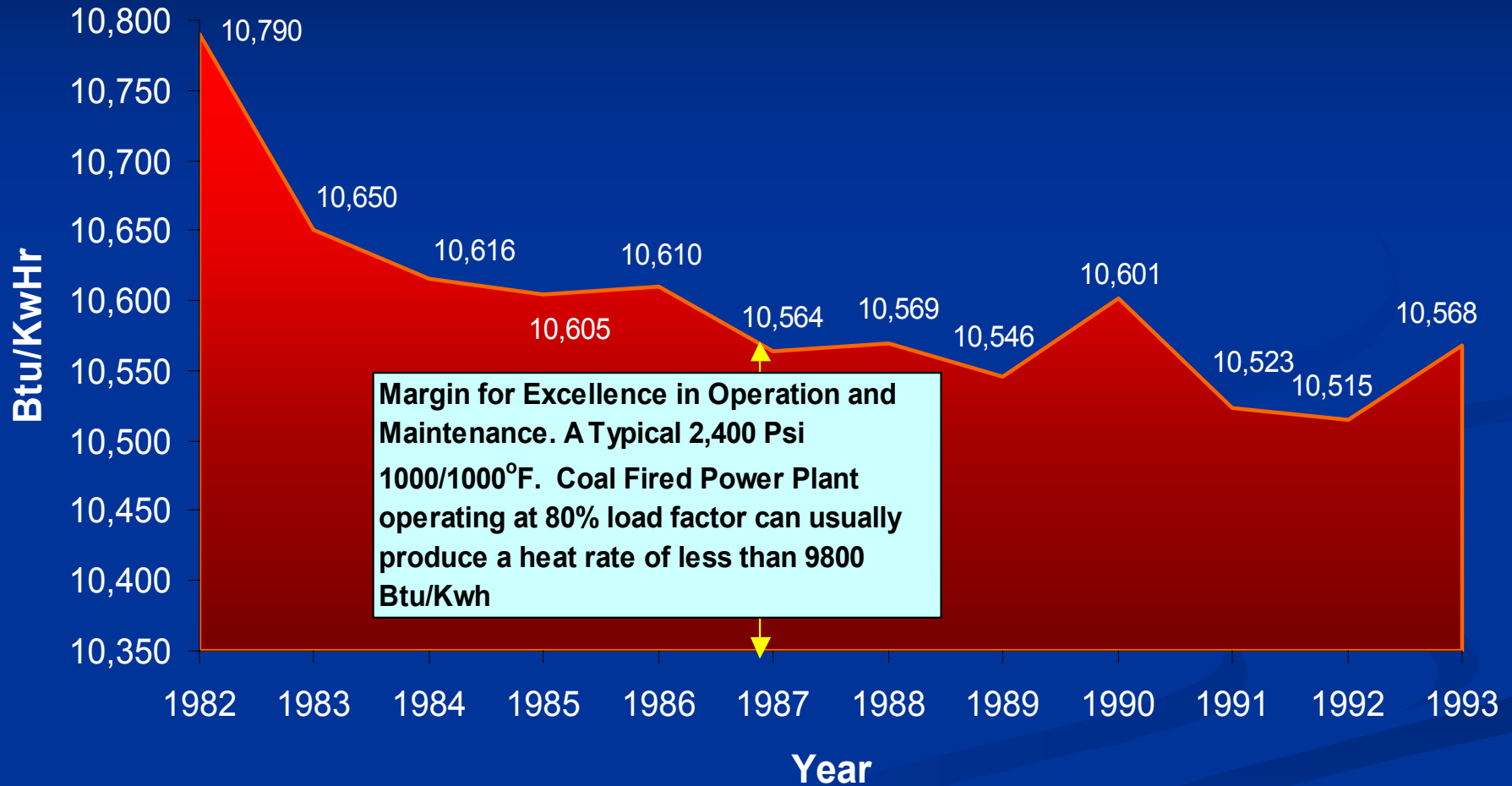

# TOP 10 Plants from EL&P Nov. 2002

Rank	State	Holding company/utility name	Plant name	2001 Capacity (MW)	Capacity factor %	Heat rate (Btu/kWh)
1	TN	Tennessee Valley Authority	Bull Run	869	88.2%	<b>8,881</b>
2	NC	Duke Power Co.	Marshall	2,090	71.3%	<b>9,026</b>
3	NC	Duke Power Co.	Belews Creek	2,240	72.0%	<b>9,092</b>
4	GA	Southern Co – Georgia Power	Wansley	1,797	72.1%	<b>9,201</b>
5	MD	Mirant Mid-Atlantic LLC	Morgantown	1,164	64.6%	<b>9,229</b>
6	CO	Xcel Energy Public Service Co of Colorado	Valmont	195	85.8%	<b>9,272</b>
7	PA	Reliant Resources	Keystone	1,711	85.1%	<b>9,338</b>
8	SC	South Carolina Electric & Gas	McMeekin	253	71.8%	<b>9,369</b>
9	PA	Edison Mission Energy	Homer City	1,884	78.5%	<b>9,391</b>
10	PA	PPL Corp	Montour	1,515	70.7%	<b>9,436</b>

Source: Energy Ventures Analysis Inc.



# Large Coal Fired Power Plants have regressed in efficiency over the last 40 years due to over-regulation and the absence of applying the fundamentals

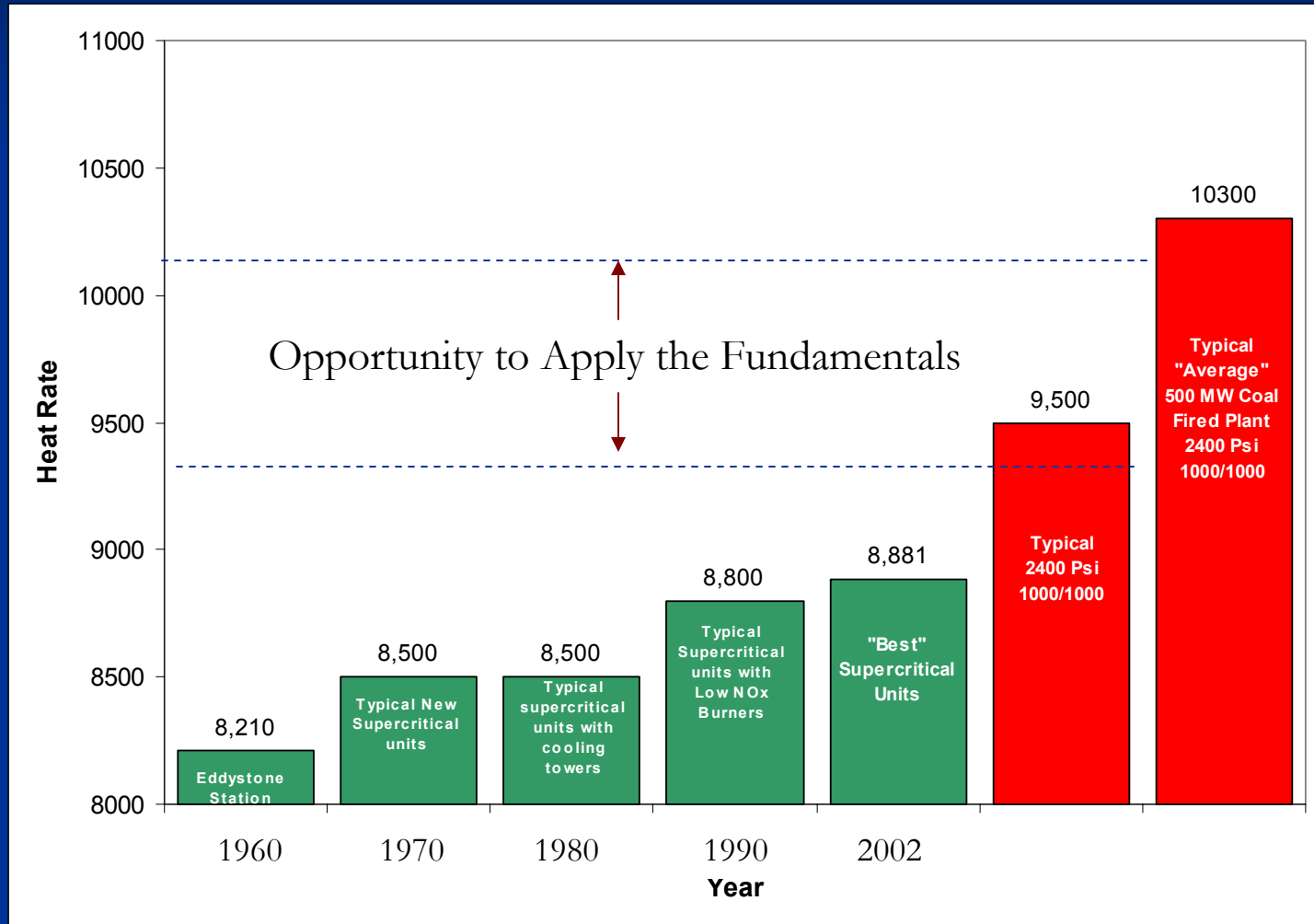

# Updates to Reduce Emissions

- Low NOx Burners
- Over Fire Air
- New DCS Control Systems
- SNCR or SCR's





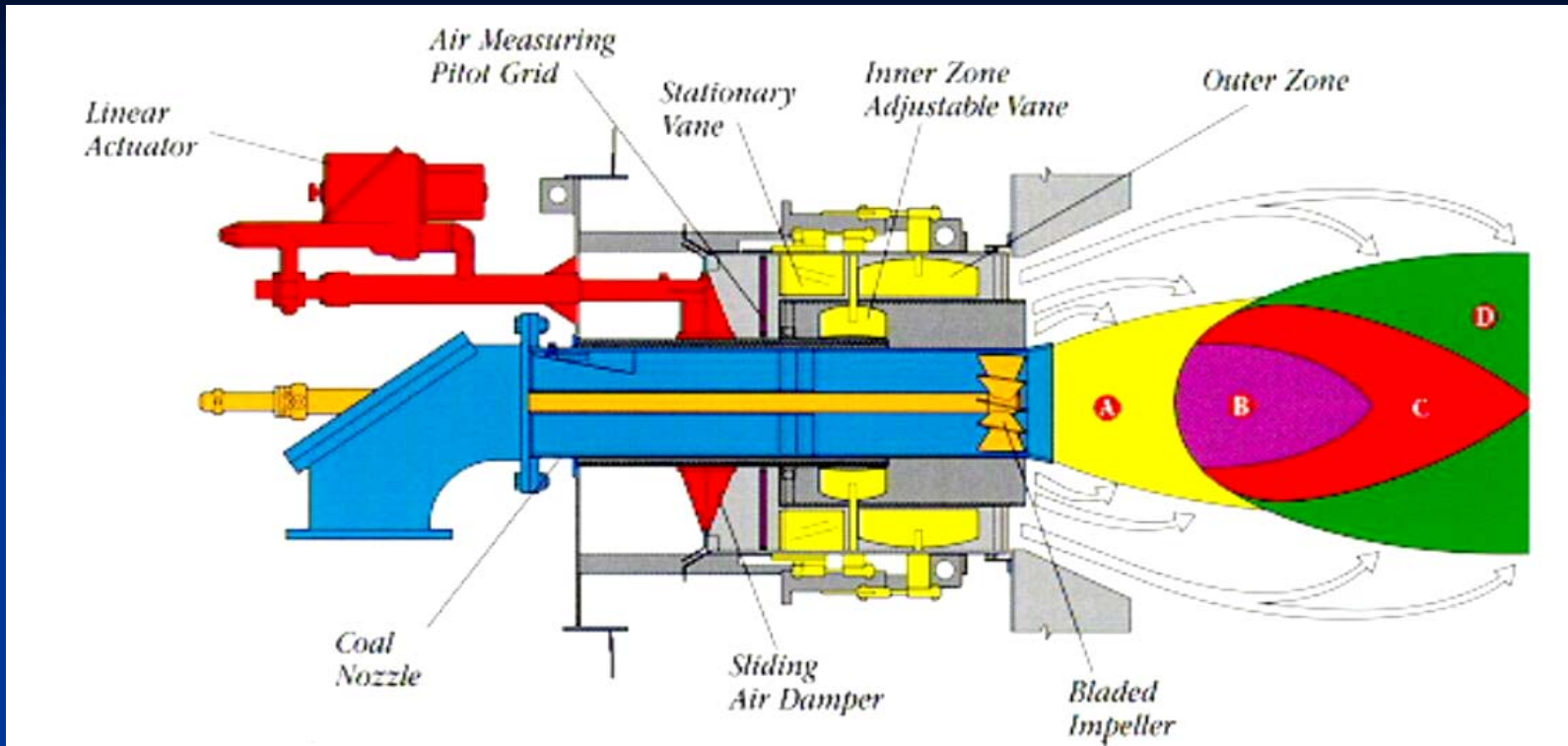

A – Devolatilization Zone  
 B – Production of Reducing Species

C – NO<sub>x</sub> Decomposition Zone  
 D – Char Oxidizing Zone

Notice how the fuel is deliberately separated from the fuel-rich core of the flame. This, of course, lengthens the flame and extends the combustion process to higher in the furnace.



# Typical Low NOx burner as compared to a pre-low NOx burner with flames approx. to scale.

State of the art 1990's – 2002 low NOx burners

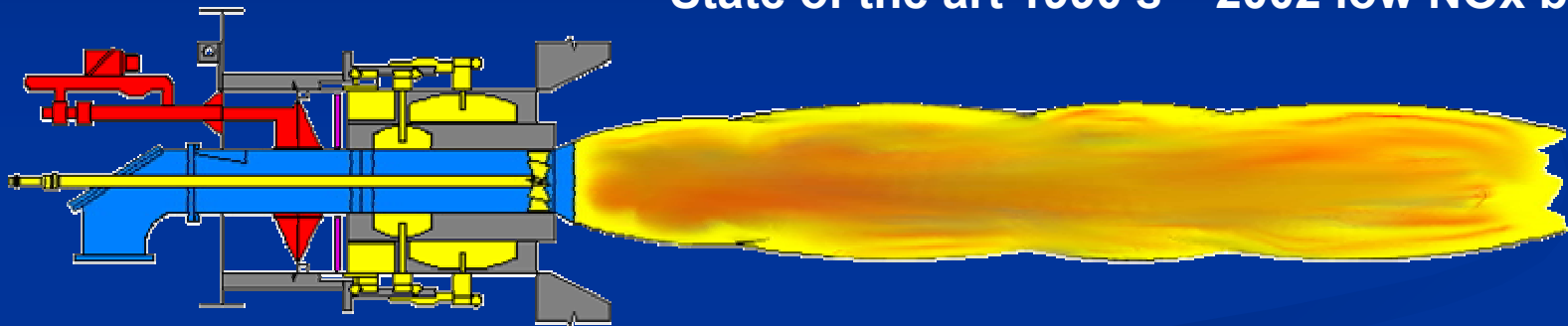

Both burners  $\approx 175$  MM Btu/hour

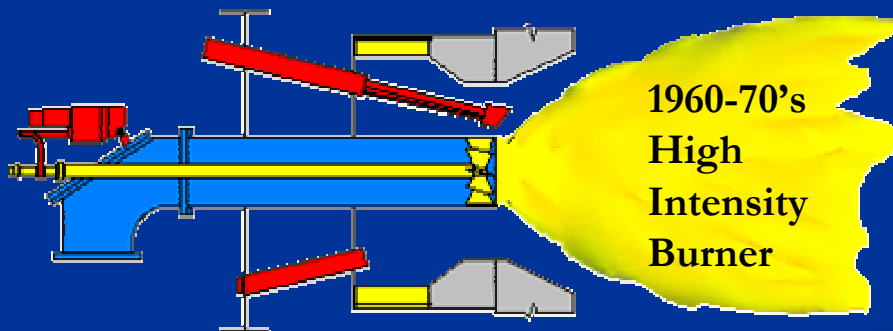

1960-70's  
High  
Intensity  
Burner

Low NOx burners and low NOx systems which utilize OFA deliberately stage combustion and consume more of the available residence time

**Boilers Retrofitted  
with low NOx  
burners still have  
the same furnace  
size and residence  
time for carbon  
char burnout.**

Residence Time

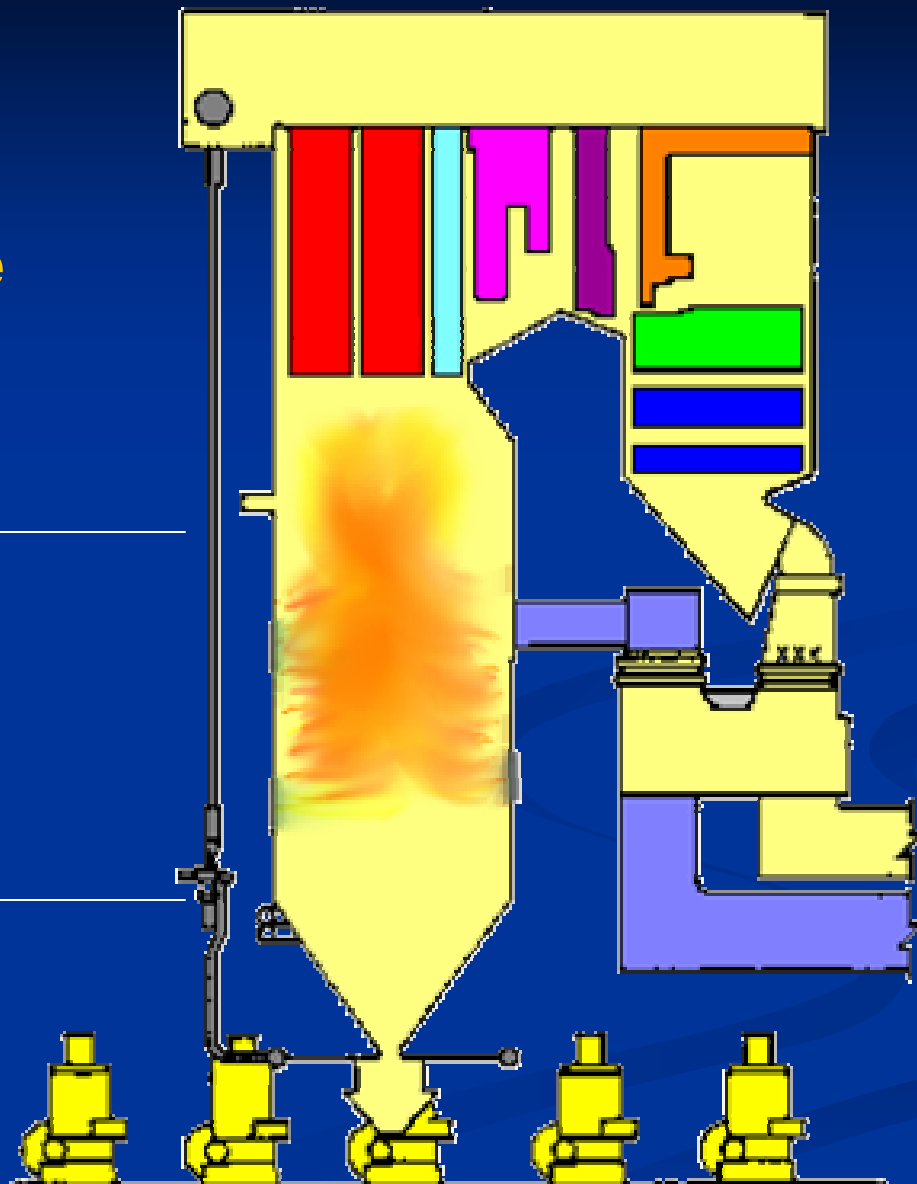

The three elements of Carbon Char burnout are absolutely essential for low unburned carbon in ash.

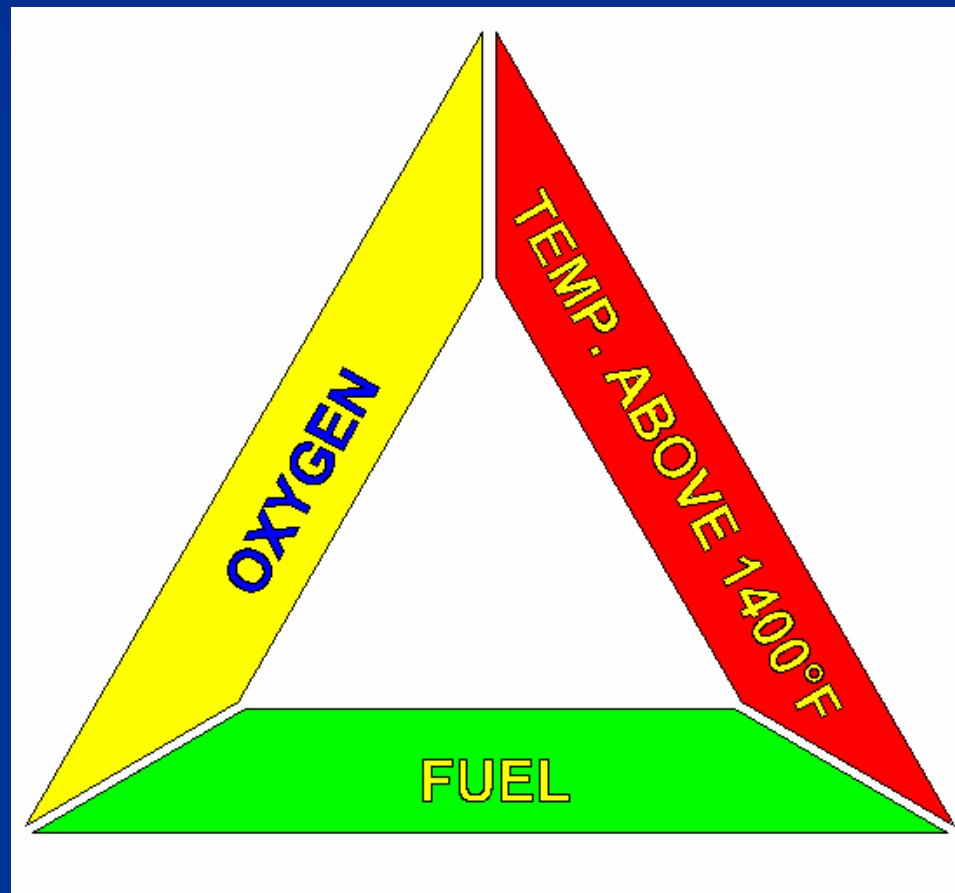

# The Usual NOx and Carbon in Ash Relationship without Addressing the Fundamentals

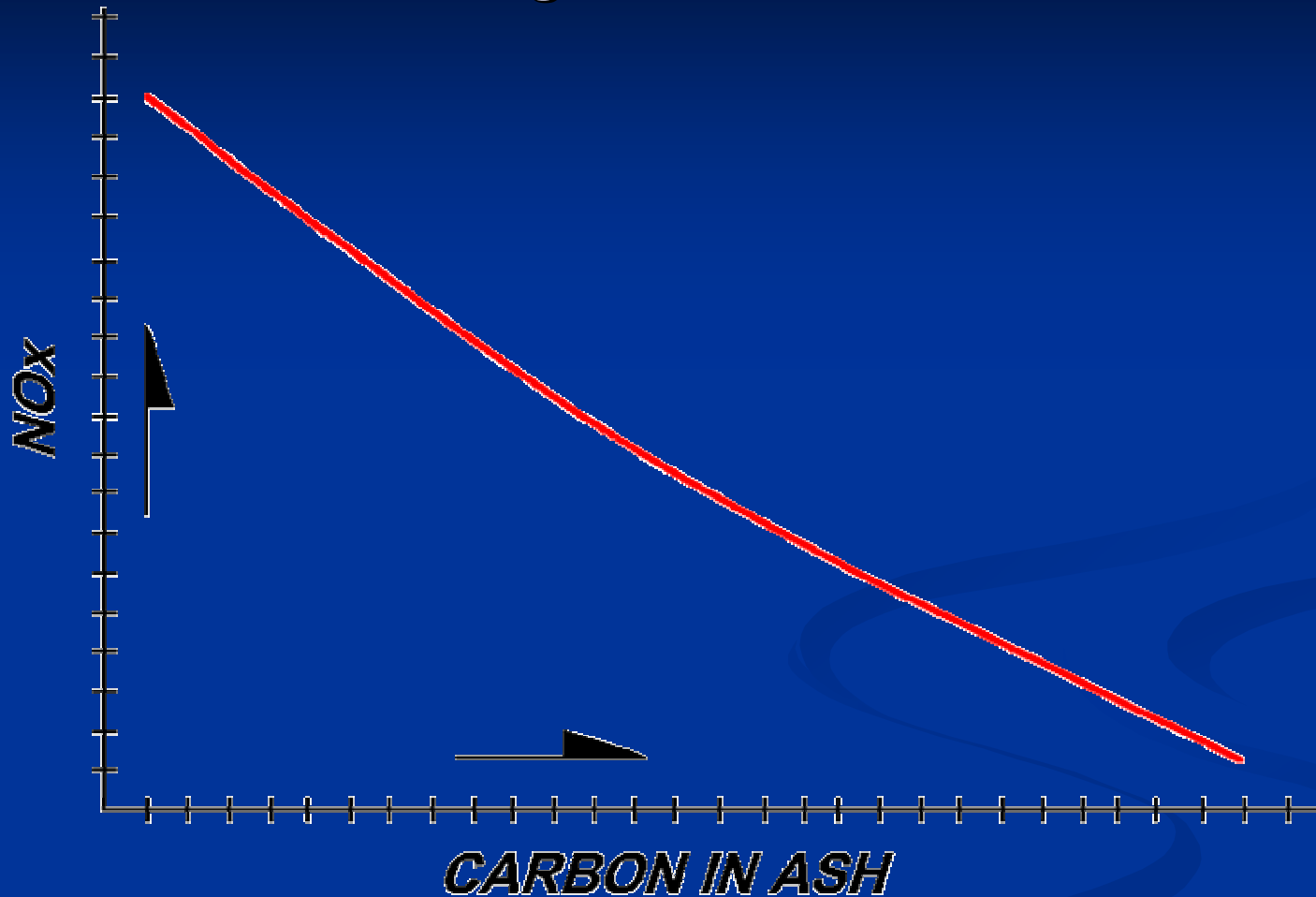

← High Intensity Combustion  
Maximum Turbulence

→ Low intensity Combustion



# Representative Flyash Sampling



There are five items, which should be measured periodically. These are leading indicators of performance opportunities:

- **Furnace Exit Gas Temperature by HVT**
- **Furnace Exit Gas Oxygen by water-cooled HVT**
- **Economizer Exit Gas Temperature**
- **Flyash Unburned Carbon by Representative Flue Inserted Sampler**
- **Stack Oxygen, (to measure overall leakage from furnace to stack)**



# Typical Boiler Temperatures

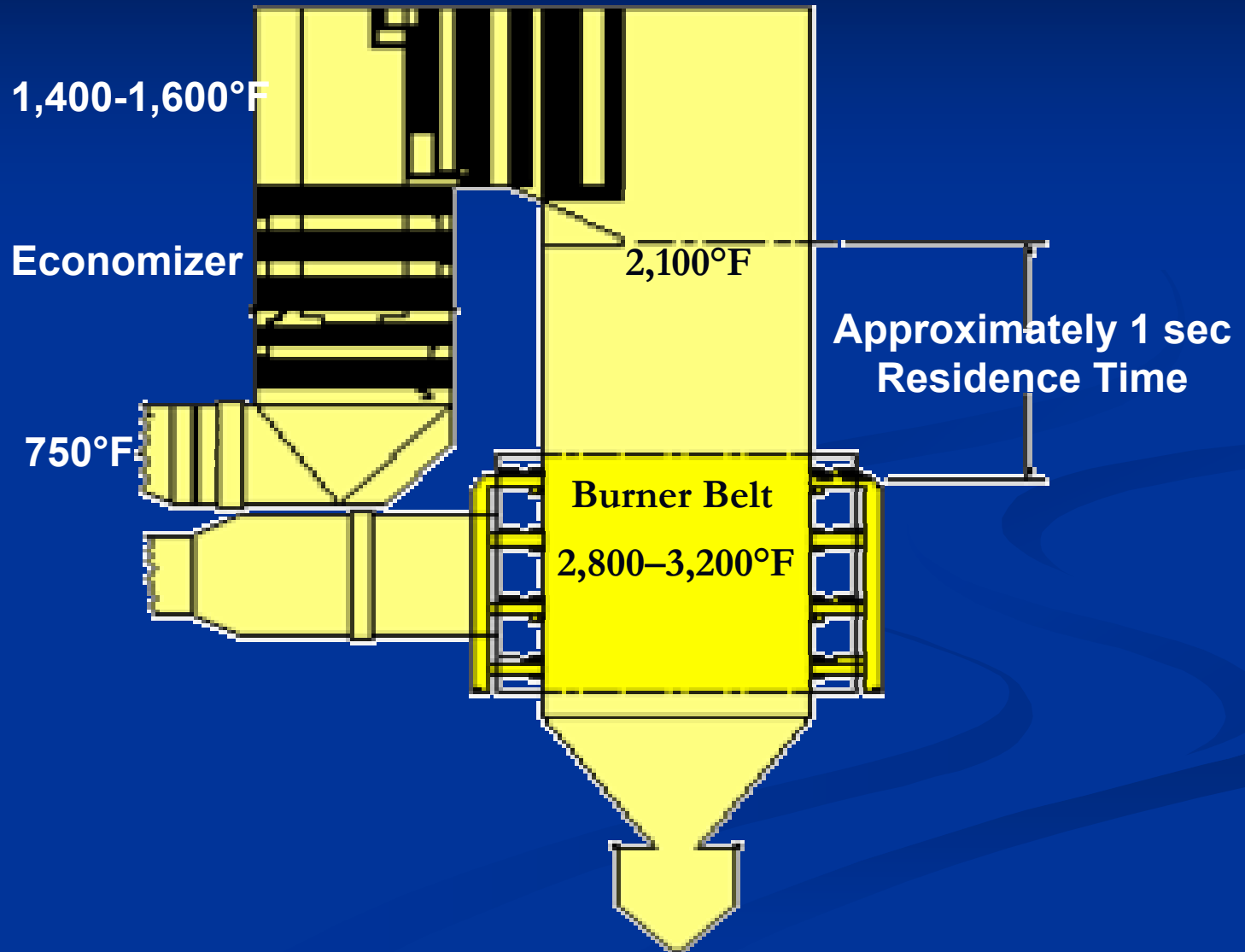



**OFA Zone**  
To Complete Combustion  
Stoichiometry Greater Than 1.0

**Burner Zone**  
Stoichiometry Less Than 1.0

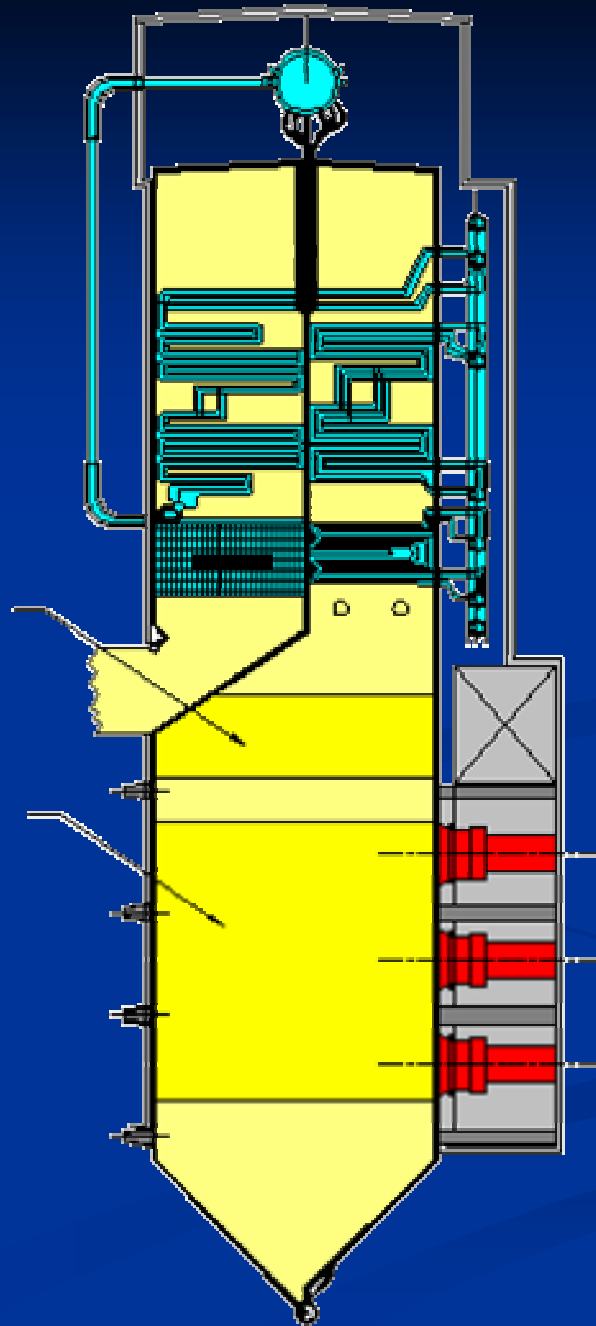

# Thirteen Essentials of Optimum Combustion

1. Furnace exit must be oxidizing preferably, 3%.



# Air in leakage continues to be a problem with 20-40 year old balanced draft boilers. The numbers shown are ideal.

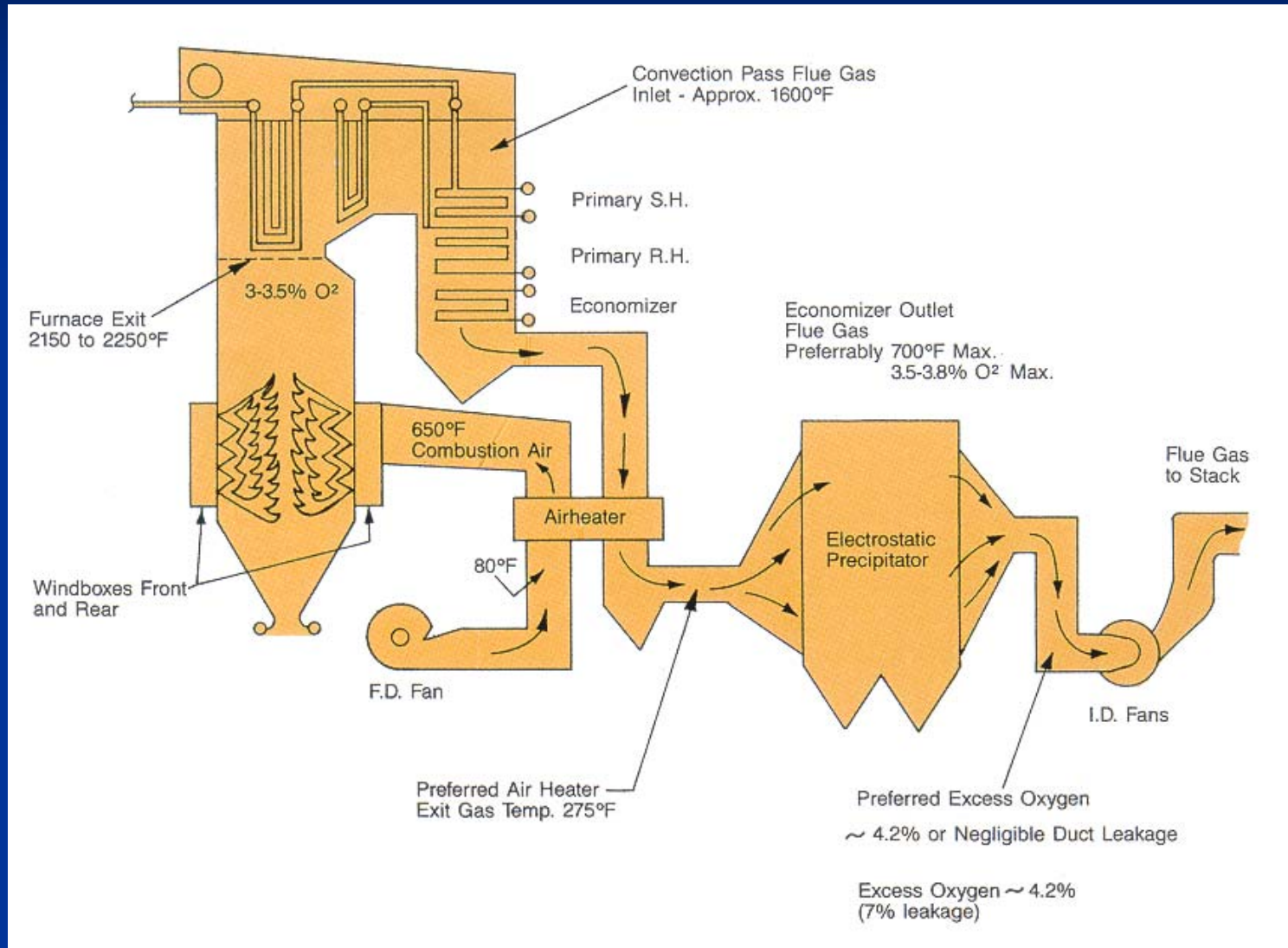

# Thirteen Essentials of Optimum Combustion

2. Fuel lines balanced to each burner by “Clean Air” test  $\pm 2\%$  or better.



# Thirteen Essentials of Optimum Combustion

3. Fuel lines balanced by “Dirty Air” test, using a Dirty Air Velocity Probe, to  $\pm 5\%$  or better.
4. Fuel lines balanced in fuel flow to  $\pm 10\%$  or better.



# Thirteen Essentials of Optimum Combustion

- Fuel line fineness shall be 75% or more passing a 200 mesh screen. 50 mesh particles shall be less than 0.1%.

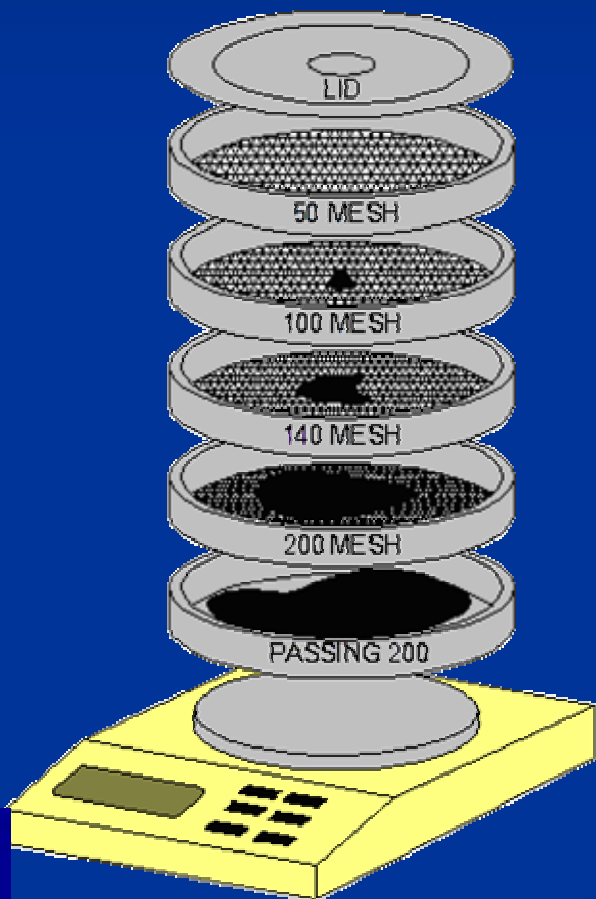

Rosin-Rammler Fineness Plot

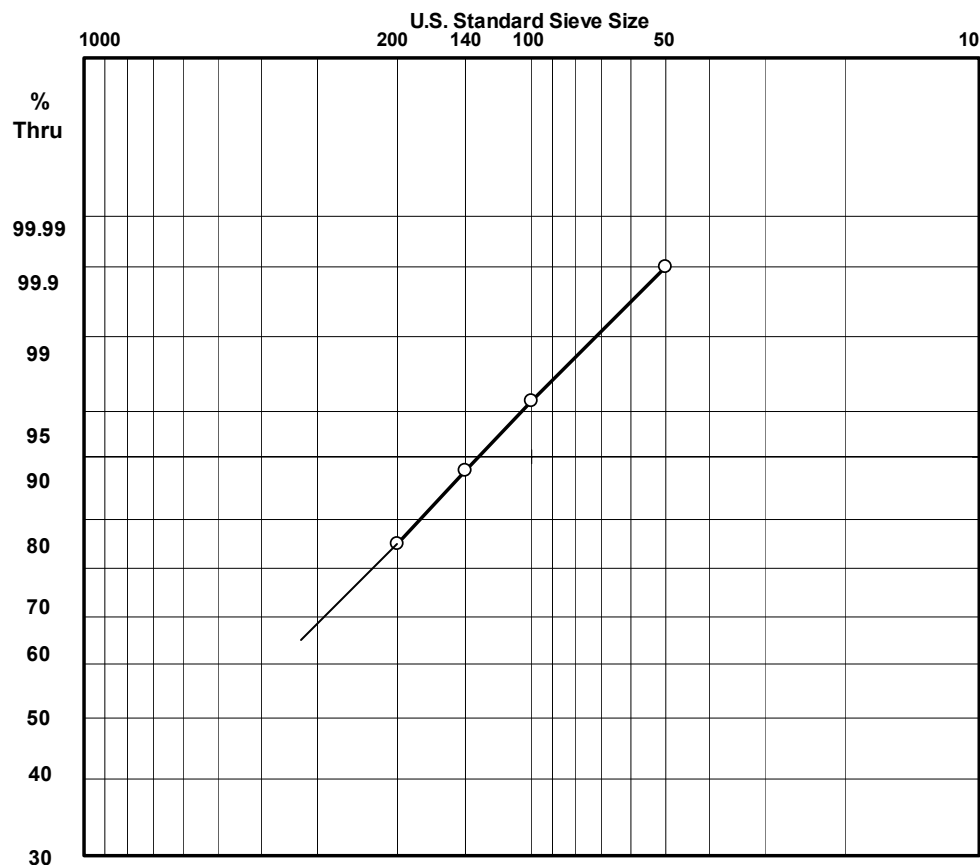

# Thirteen Essentials of Optimum Combustion

6. Primary airflow shall be accurately measured & controlled to  $\pm 3\%$  accuracy.
7. Overfire air shall be accurately measured & controlled to  $\pm 3\%$  accuracy.



# Thirteen Essentials of Optimum Combustion

8. Primary air/fuel ratio shall be accurately controlled when above minimum.
9. Fuel line minimum velocities shall be 3,300 fpm.

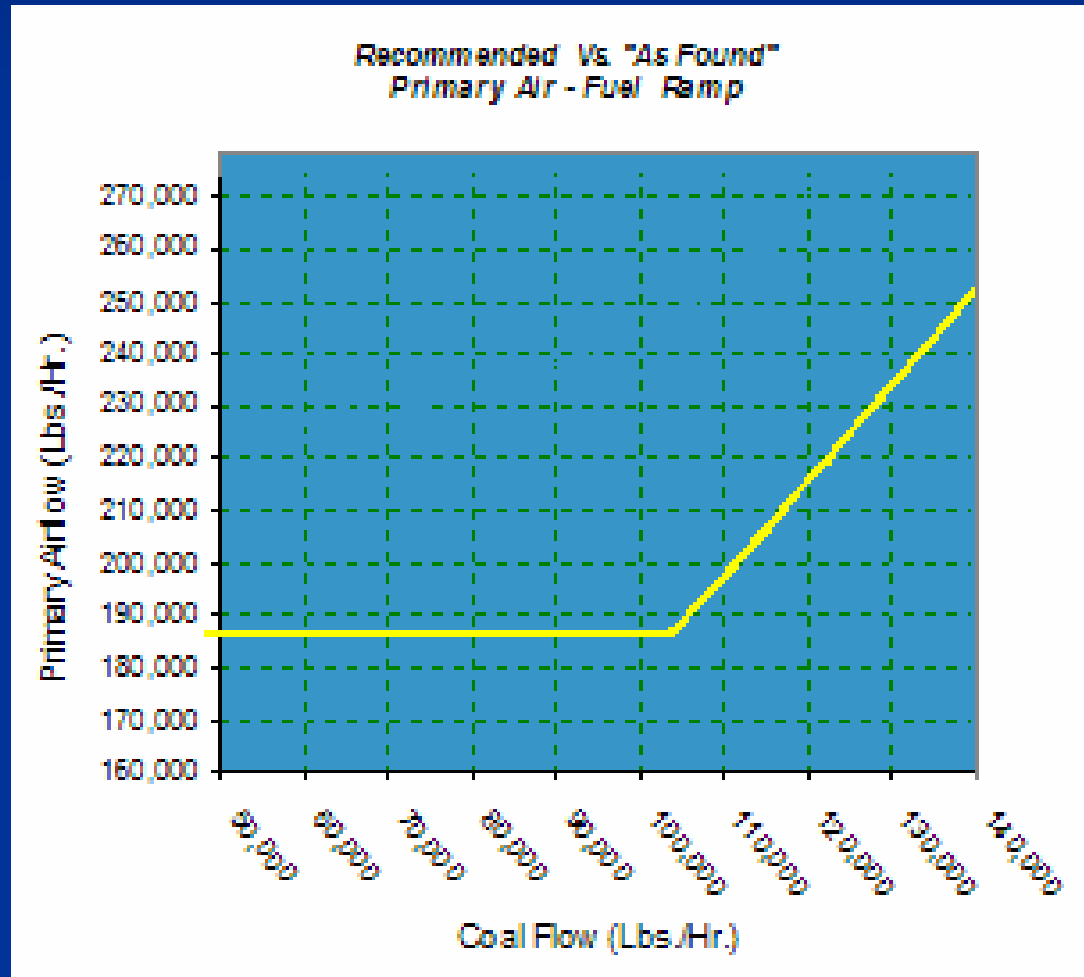



# Thirteen Essentials of Optimum Combustion

10. Mechanical tolerances of burners and dampers shall be  $\pm 1/4$ " or better.



# Thirteen Essentials of Optimum Combustion

11. Secondary air distribution to burners should be within  $\pm 5\%$  to  $\pm 10\%$ .

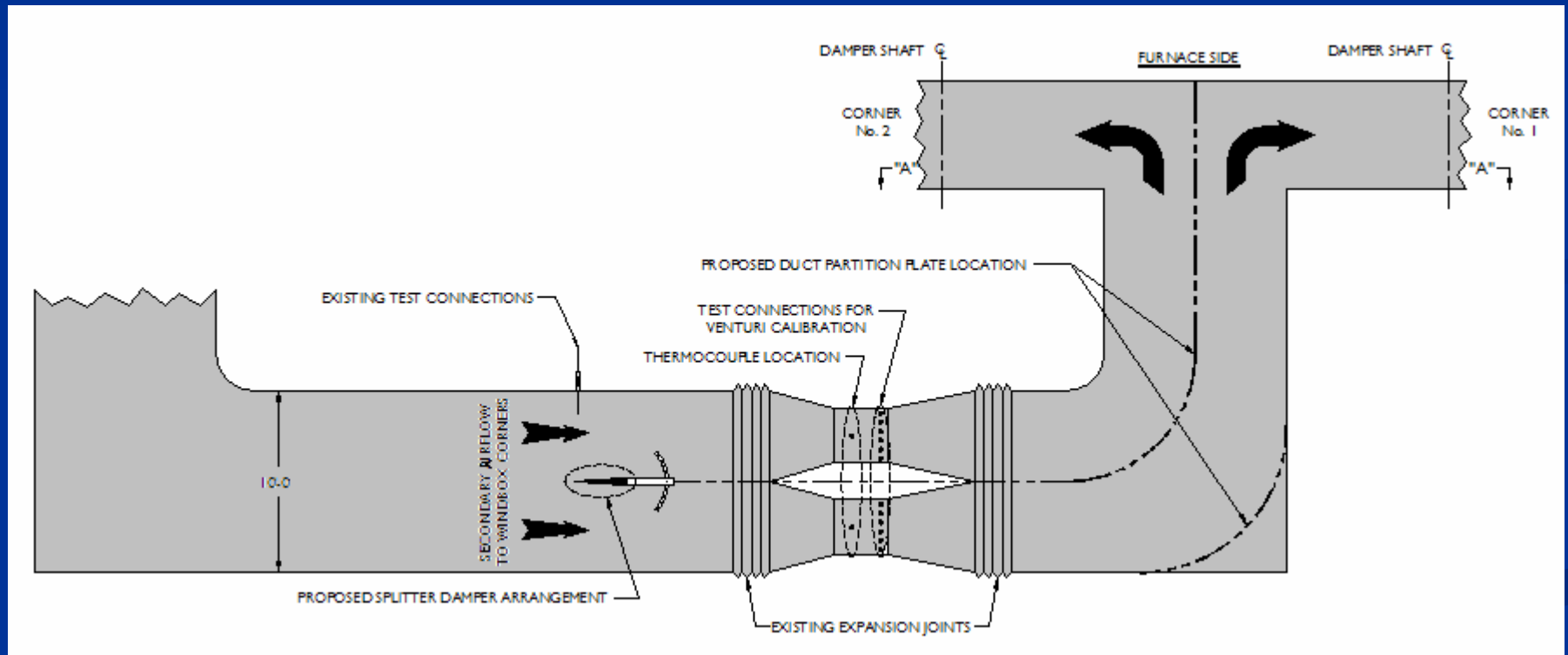

# Thirteen Essentials of Optimum Combustion

12. Fuel feed to the pulverizers should be smooth during load changes and measured and controlled as accurately as possible. Load cell equipped gravimetric feeders are preferred.



# Thirteen Essentials of Optimum Combustion

13. Fuel feed quality and size should be consistent. Consistent raw coal sizing of feed to pulverizers is a good start.

Raw Fuel Size vs. Percent Fuel Feed Rate

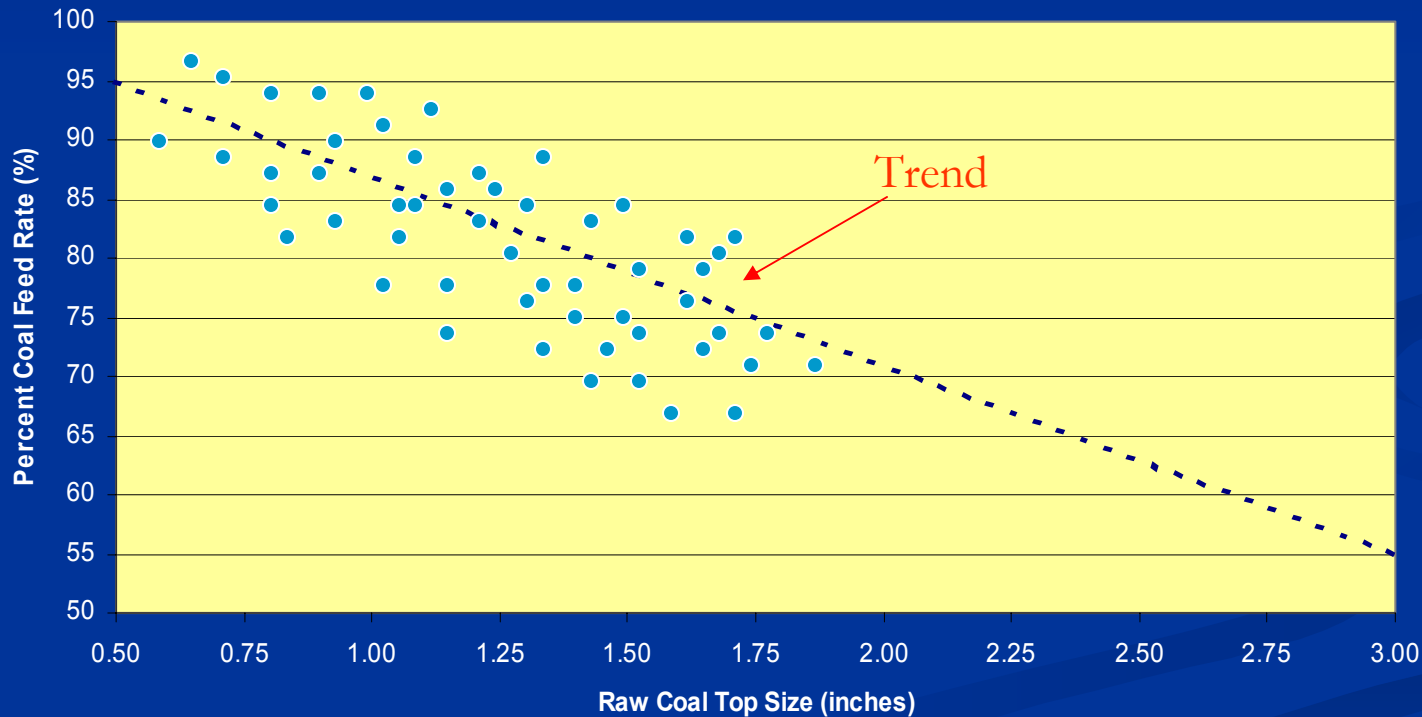

This data is based on Actual Recorded conditions of an EL 56; for informational purposes only. All data recorded for coal with the same HGI.



# Pulverized Coal Fueled Boilers Built 30 Years Ago with Original Pulverizers Have a 25-30% Capacity Penalty When Firing Low Sulfur, Low HGI Eastern Fuels.

Normal Design for 60's – 70's pulverizers

Approx. 25-30% reduction in real pulverizer capacity

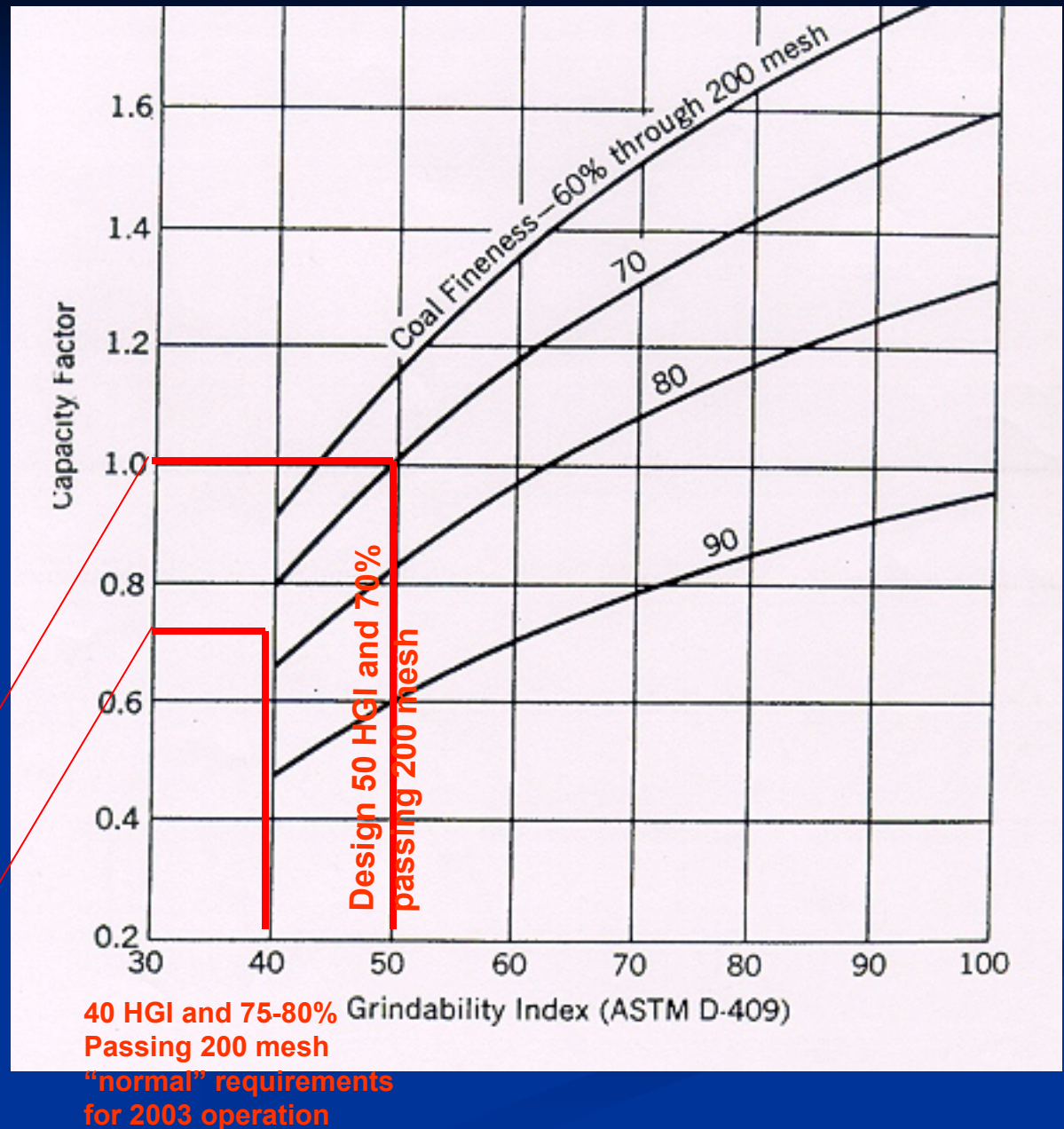

# Airflow and Fuel line balancing, What are the benefits?



# Typical 450 MW Coal Fired Unit Comprehensive Boiler Air and Fuel Balancing

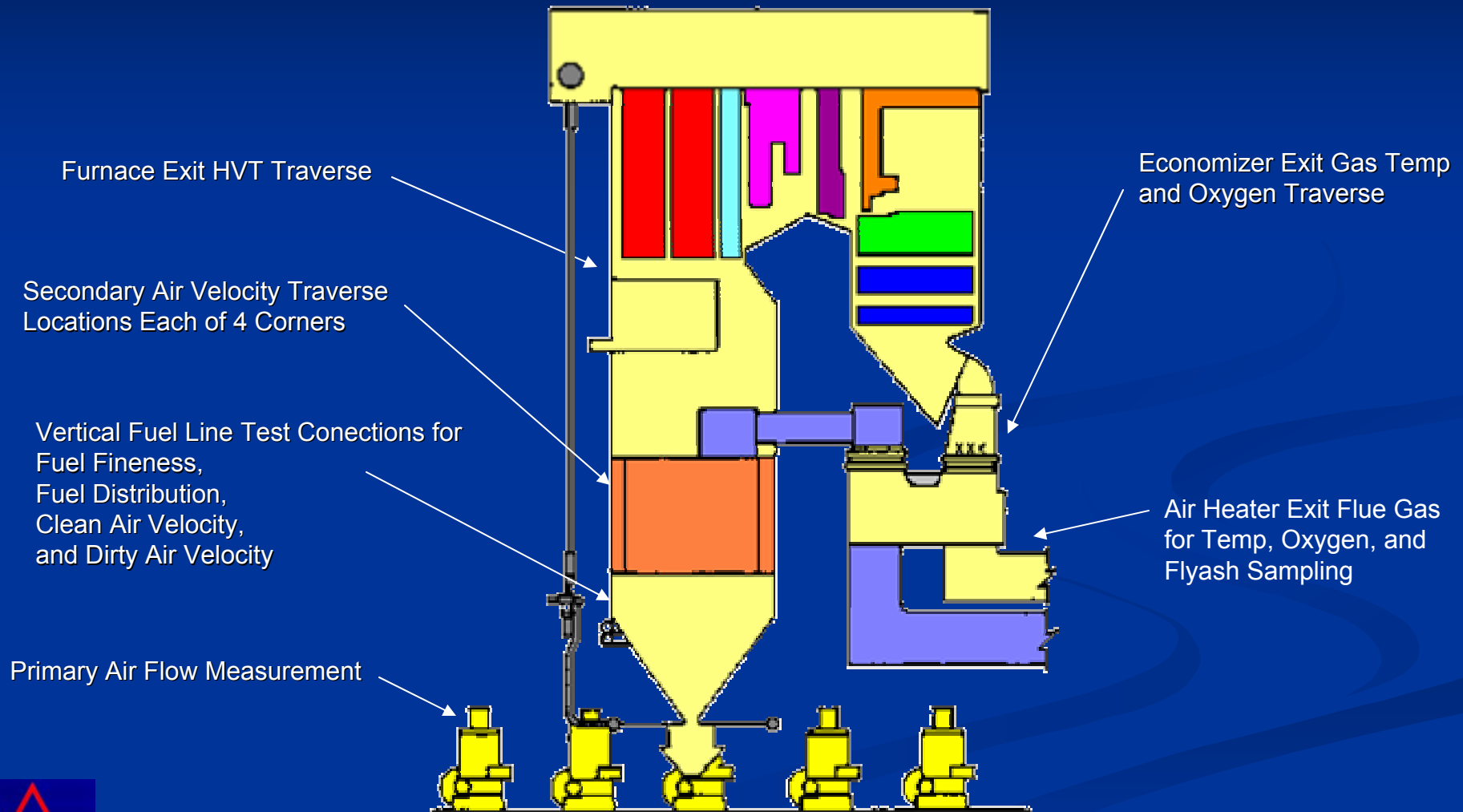

**Unit heat rate was reduced by applying the fundamentals to the fuel and air inputs to the furnace.**

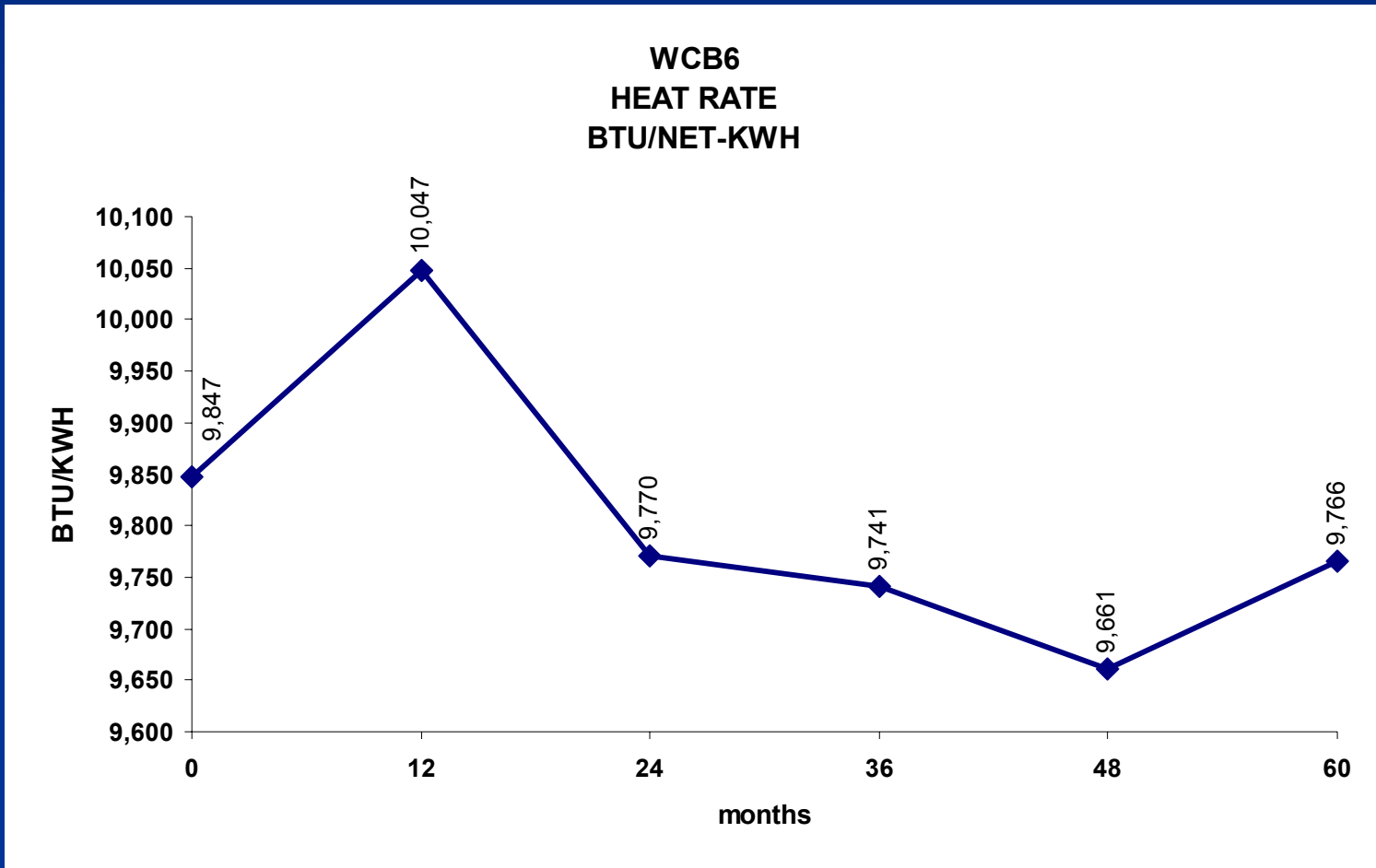



# Capacity Factor Was Significantly Increased Due to Reduced Slagging

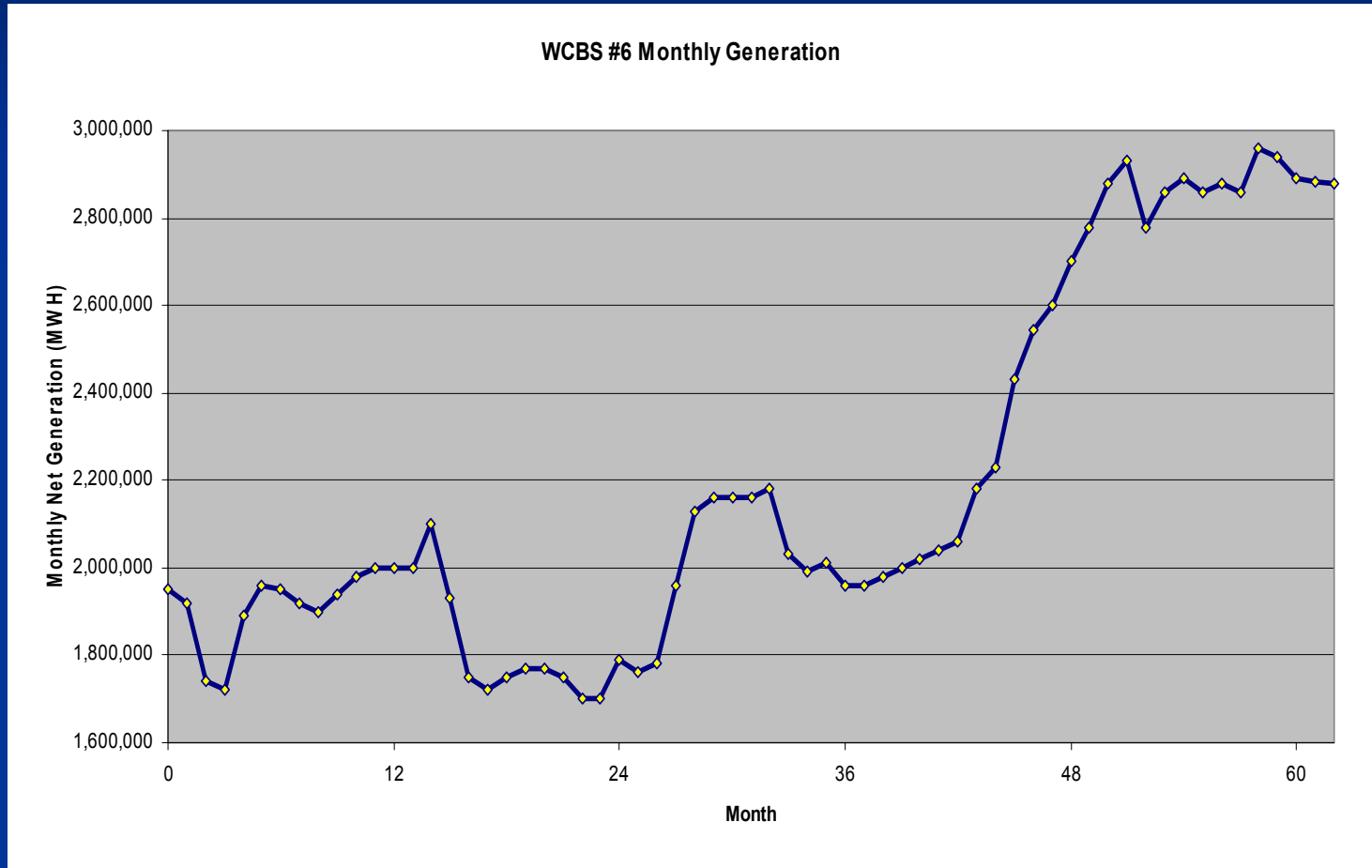

# Operations and Maintenance Controlled Variables that Affect Heat Rate

1. Flyash unburned carbon content
2. Bottom ash carbon content
3. Airheater leakage
4. A.H. Exit Gas Temperature (corrected for leakage)
5. Furnace Exit Gas Temperature and its effect on superheater de-superheating spray flow
6. Air in-leakage
7. S.H. Steam Temperature
8. R. H. Steam Temperature
9. Primary airflow (tempering air which bypasses the airheaters).



# Flyash Carbon Content

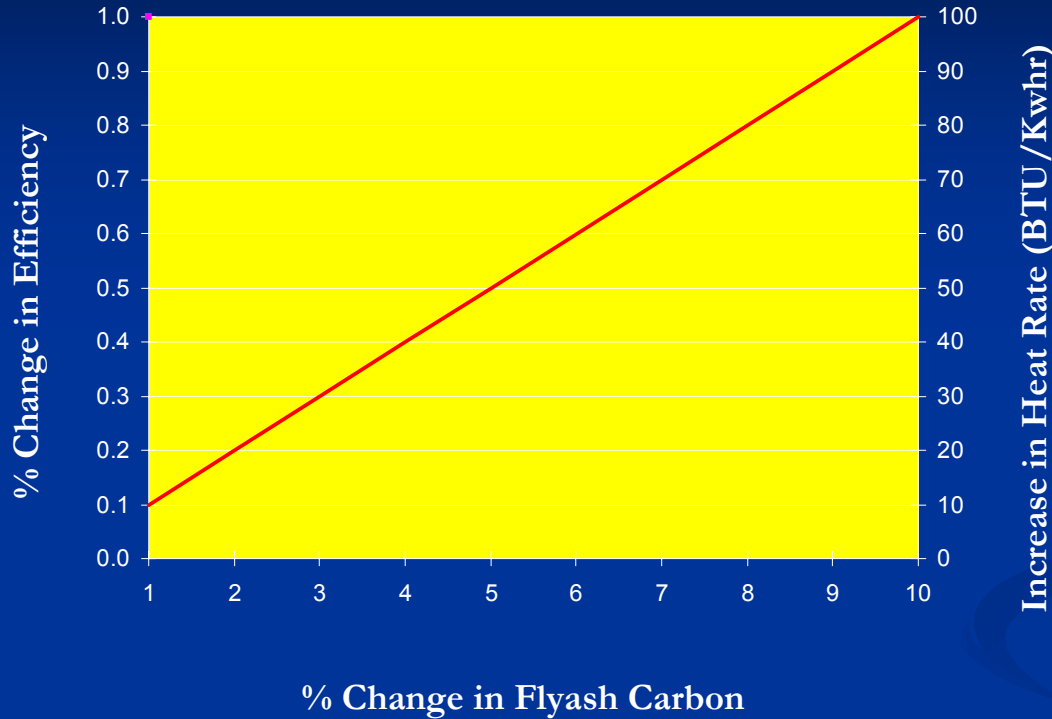

**1% Change in Flyash Carbon Results in about a 1/10% change in Boiler Efficiency or about 10 BTU/Kwhr heat reat increase**

10. Auxiliary power consumption (fan clearances, airheater pluggage, air in leakage, sootblowing air compressors, pulverizers, boiler fouling, which creates draft losses, etc...)
11. Sootblower operation
12. Boiler Exit Gas Temperature (economizer exit)
13. Furnace, boiler exit and airheater exit excess oxygen content
14. De superheating spray water flow into the reheater.
15. Cycle losses due to vent and drain valve leakage.
16. Steam purity and turbine deposits from boiler water carryover
17. Pulverizer air in-leakage for exhaustor equipped pulverizers
18. Pulverizer coal spillage



# To Maintain Optimum Performance

Weekly, monthly, and quarterly tests of:

- Coal fineness
- Furnace exit HVT Testing
- Boiler Air In-Leakage
- Air Heater Leakage
- Flyash Unburned Carbon



# Testing does not correct a heat rate problem



**But testing is necessary to identify opportunities for improvement**



**A problem identified is a problem half solved...**



# Recommended Periodic Testing

- Weekly representative flyash carbon content sampling
- Monthly coal fineness tests
- Monthly airheater performance tests
- Quarterly oxygen rise tests from the furnace to the stack
- Quarterly coal feeder calibrations
- Quarterly high precision coal fineness and distribution tests
- Semi-annual airflow device calibrations
- Semi-annual fuel line clean-air testing to prove  $\pm 2\%$  balance
- Pre-outage comprehensive boiler evaluation tests to fine tune the outage work list.





**The best approach to achieving close to design heat rate is a real team effort of:**

**Operations**

**Maintenance**

**Heat Rate Engineers**

**Plant Engineers/Results Engineers**

